

IDRA XPRESS

Series Die Casting Machine

Xpress series intelligent die casting machine, clamping force ranges from 300 to 900 ton, and can provide Italy's cutting-edge technology to more customers. Stable, precise and efficient production enhances the competitiveness of its users.

Worldwide Recognized Safety Standard

The machines comply with CE standard requirement. A clean and modern design outlook appearance adopts a total enclosure safety guard design providing a high degree of protection.

Smart Injection

The injection unit of the machine adopts the IDRA proven design, providing a high performance injection, resulting in more accurate casting pressure, more stable injection speed, and easier to operate.



Reliability and Stability

IDRA toggle system, ingenious design of more than 70 years experience.

Energy Saving

Equipped with energy saving system, saves 50% or more energy consumption and reduce operation cost. The comparison is based on the same machine model equipped with a fixed displacement pump.

Quick Die Change (Optional)

Nowadays production requires high efficiency, demanding die changes in the shortest possible time. Optional hydraulic tie bar extraction device can pull tie bar out completely, thus the tie bar will not be damaged whilst changing the tool. Optional hydraulic die clamping devices can make die changing easier and save time.

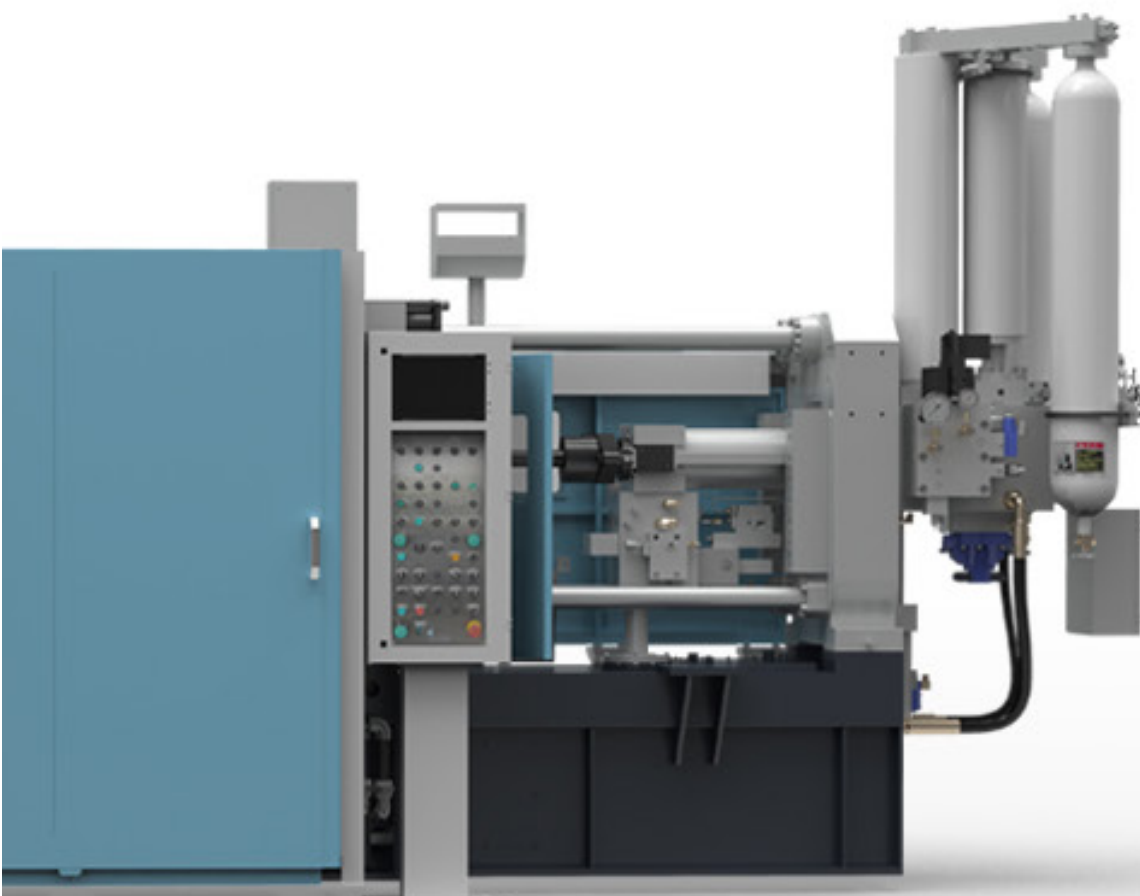

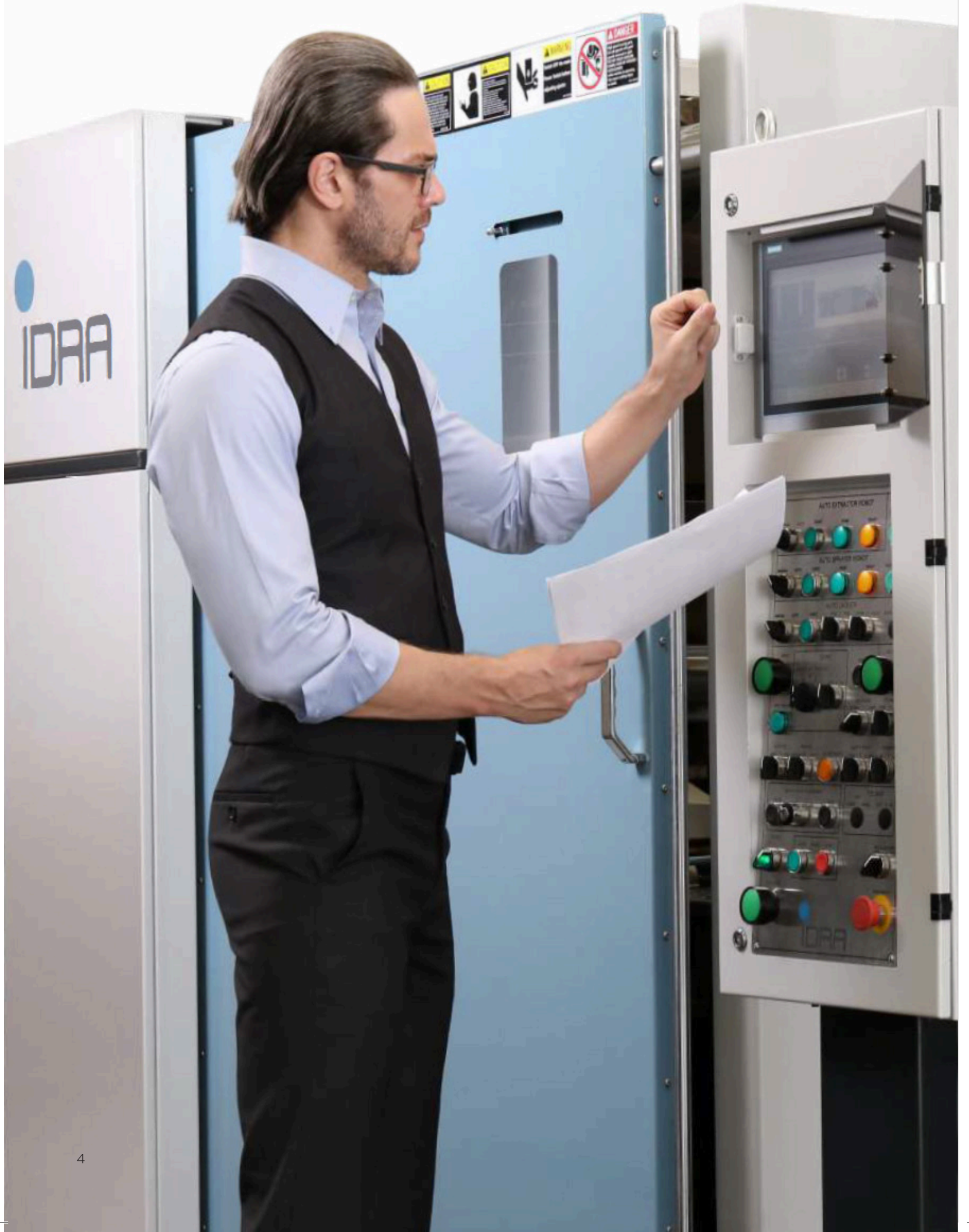

IDRA XPRESS

The Core of Die Casting Cell

Real Time Control & Integrated Solutions

Control technology for casting high quality components

IDRA unique real-time control system, gives each die casting process excellent quality and casting consistency. The intelligent process control system greatly prolongs the service life of the die.

IDRA injection unit ensures reliable production

Injection control technology improves injection performance in the way of pressure & speed control precision. High dynamic injection force ensures the best metal filling. with a precise and stable casting pressure, complemented by convenient adjustment.

User friendly operation system

The Operator interface is intuitive and easy to understand, allowing operators to set-up the die casting machine and save parameters easily. Integrated process and diagnostics, achieve professional casting solution.

SPC quality monitoring

Large capacity data storage system.

Powerful function, clear and accurate injection process curve display.

Major Process Parameters analysis for SPC and quality trend check.

Remote Diagnosis and trouble shooting

The system is available to achieve remote monitoring, malfunction diagnostic and trouble shooting via remote internet connection.

IDRA XPRESS

High Efficiency Automation Integrated Solutions

IDRA can provide the customized automatic die casting cell solutions according to the products of the customer, which improves production efficiency and reduces labor cost.

Automatic Die Casting Cell

Provide customized automatic die casting cell solutions to achieve various automatic production processes and enable the traceability of products.

Sprayer

High-atomization nozzles improve the surface quality of die casting parts. Flexible and precise grouping control, effectively reduce the consumption of release agent and compressed air; Sprayer head can be customized according to the die shape, which achieves fixed-point quantitative spraying, which greatly improves production efficiency.

Trim Press

Energy saving servo system can save energy consumption and reduce the trimming cycle time. The trim press can fulfill requirements of different applications.

Energy Saving and Environmentally friendly

The die casting cell uses energy saving system, which can greatly save energy consumption. The fume extraction system and die releasing agent collection system can reduce the waste discharge pollution.

DC PRESS

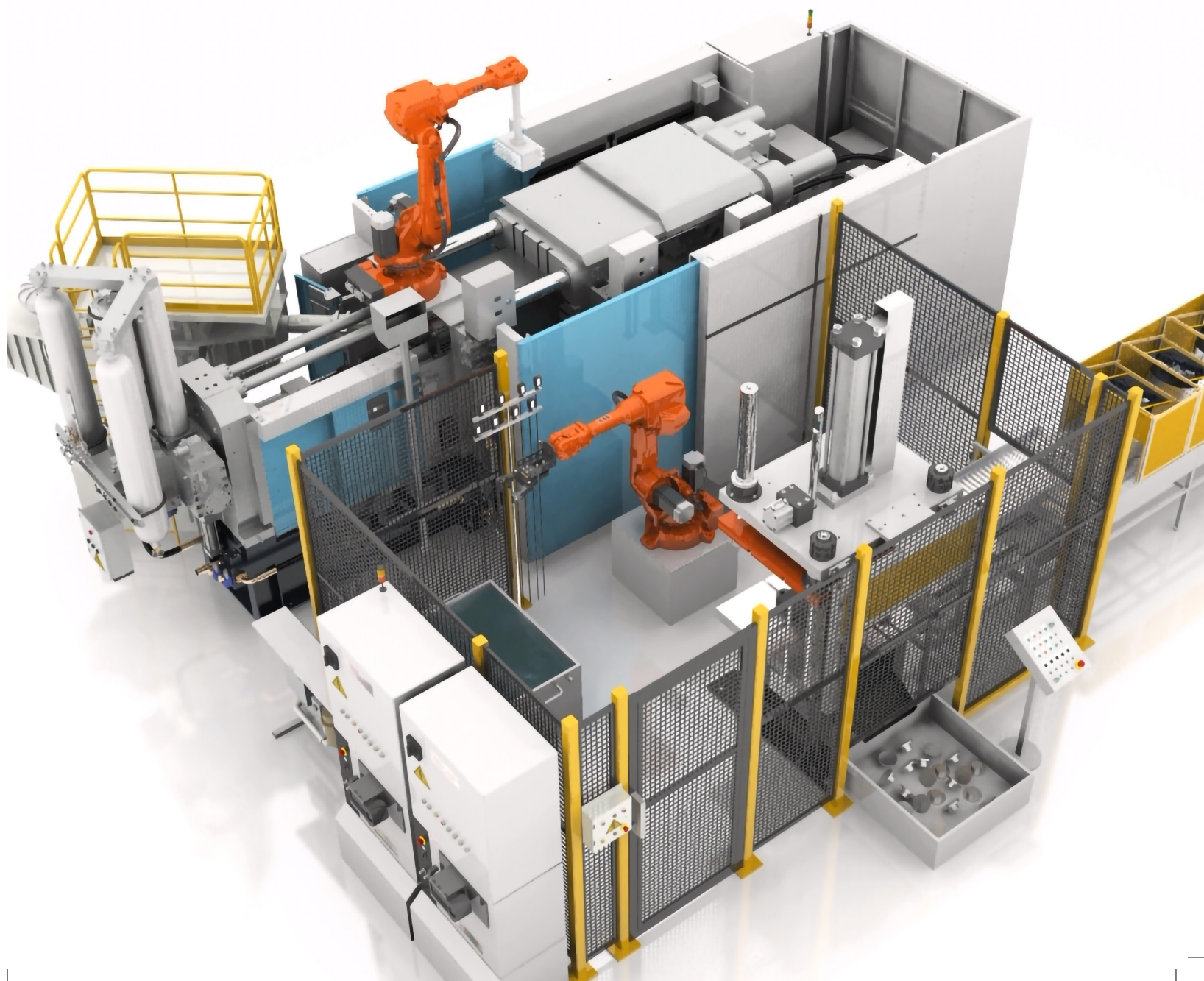

XPRESS MACHINE DATA

MODEL		XPRESS 300
Clamping force	kN	3000
Clamping stroke	mm	460
Die height (Min. - Max.)	mm	250-650
Platen dimensions (H x V)	mm	860 X 860
Space between tie bars	mm	560 X 560
Ejection force	kN	157
Ejection stroke	mm	105
Injection force (back pressure 0 bar)	kN	419
Injection stroke	mm	450
Plunger diameter	mm	50-70
Shot weight (Al alloy)	kg	1,6 - 3,2
Casting pressure (intens, back pressure 0 bar)	bar	2100-1050
Casting area	cm ²	140-285
Max. casting area (400 bar)	cm ²	750
Shot Injection position	mm	0, -125
Working pressure	bar	160

XPRESS 420	XPRESS 560	XPRESS 700	XPRESS 900
-------------------	-------------------	-------------------	-------------------

4360	5850	7500	9200
------	------	------	------

600	700	780	900
-----	-----	-----	-----

250-700	300-800	400-900	450-1000
---------	---------	---------	----------

1019 X 1019	1160 X 1160	1320 X 1320	1400 X 1400
-------------	-------------	-------------	-------------

669 X 669	760 X 760	860 X 860	910 X 910
-----------	-----------	-----------	-----------

246	246	385	385
-----	-----	-----	-----

140	165	175	200
-----	-----	-----	-----

457	531	615	806
-----	-----	-----	-----

500	600	650	700
-----	-----	-----	-----

60-80	70-90	80-100	80-110
-------	-------	--------	--------

2,6 - 4,7	4,3 - 7,1	6,1 - 9,5	6,5 - 12,4
-----------	-----------	-----------	------------

1600-900	1350-800	1200-750	160-80
----------	----------	----------	--------

270-480	430-730	625-1000	575-1150
---------	---------	----------	----------

1090	1462,5	1875	2300
------	--------	------	------

0, -175	0, -175	0, -250	0, -250
---------	---------	---------	---------

160	160	160	160
-----	-----	-----	-----

IDRA RESERVES THE RIGHT TO MAKE ANY TECHNICAL IMPROVEMENTSWITHOUT FURTHER NOTICE

Platen Dimension

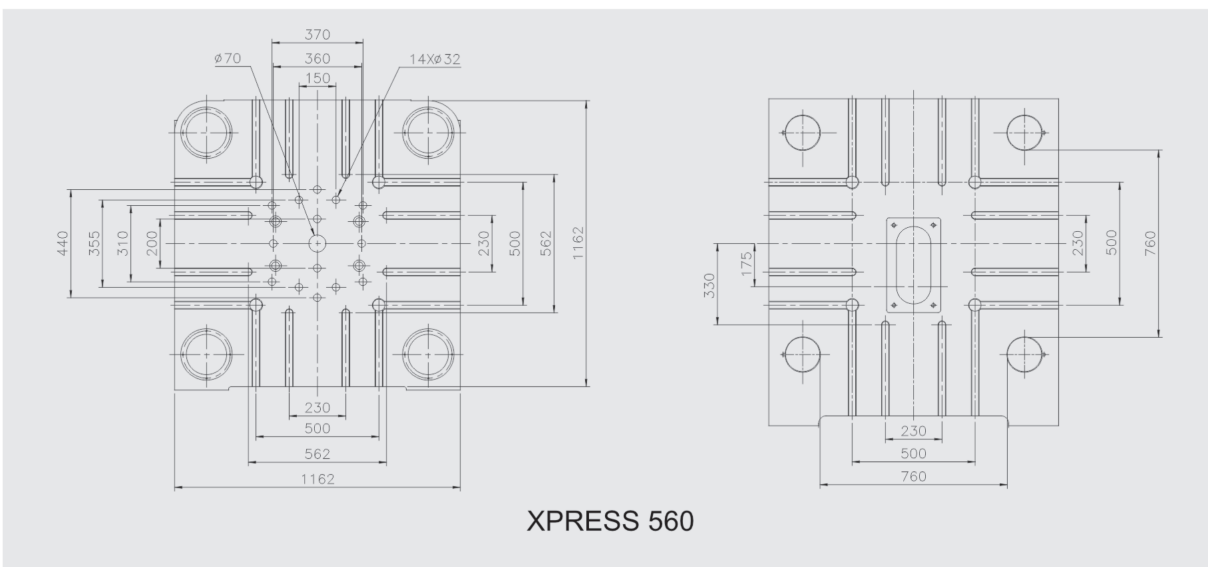
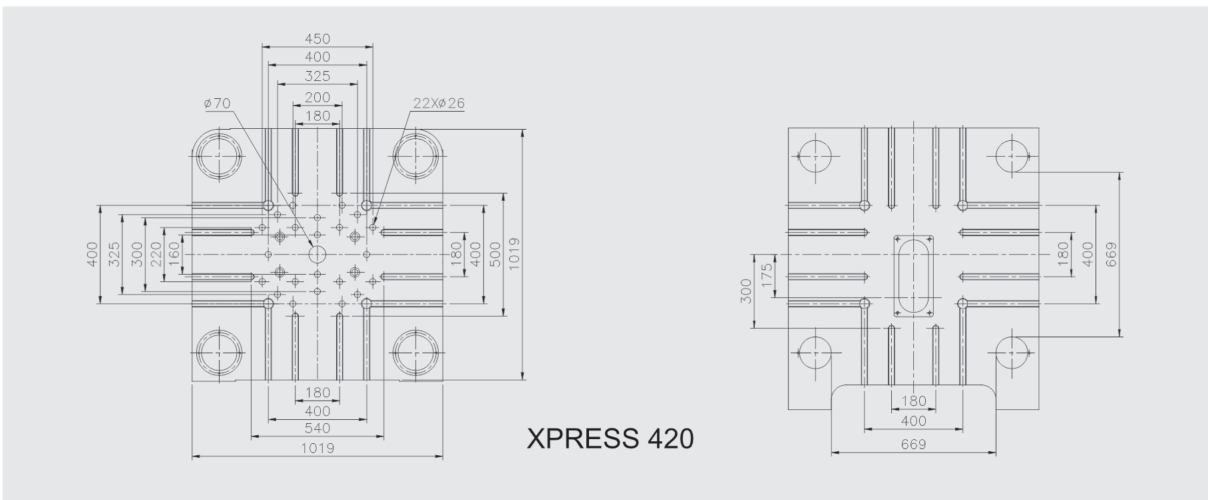
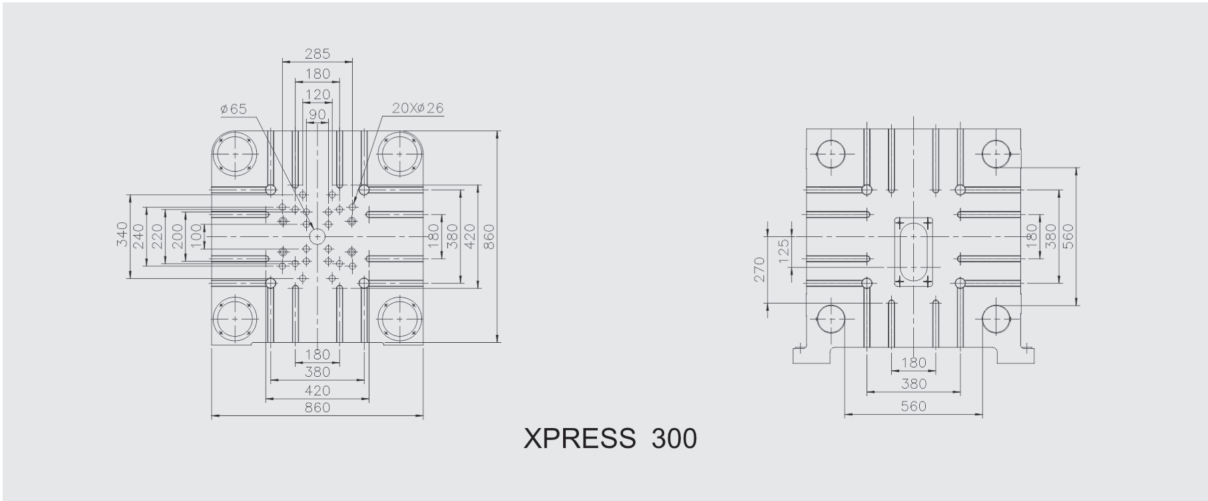

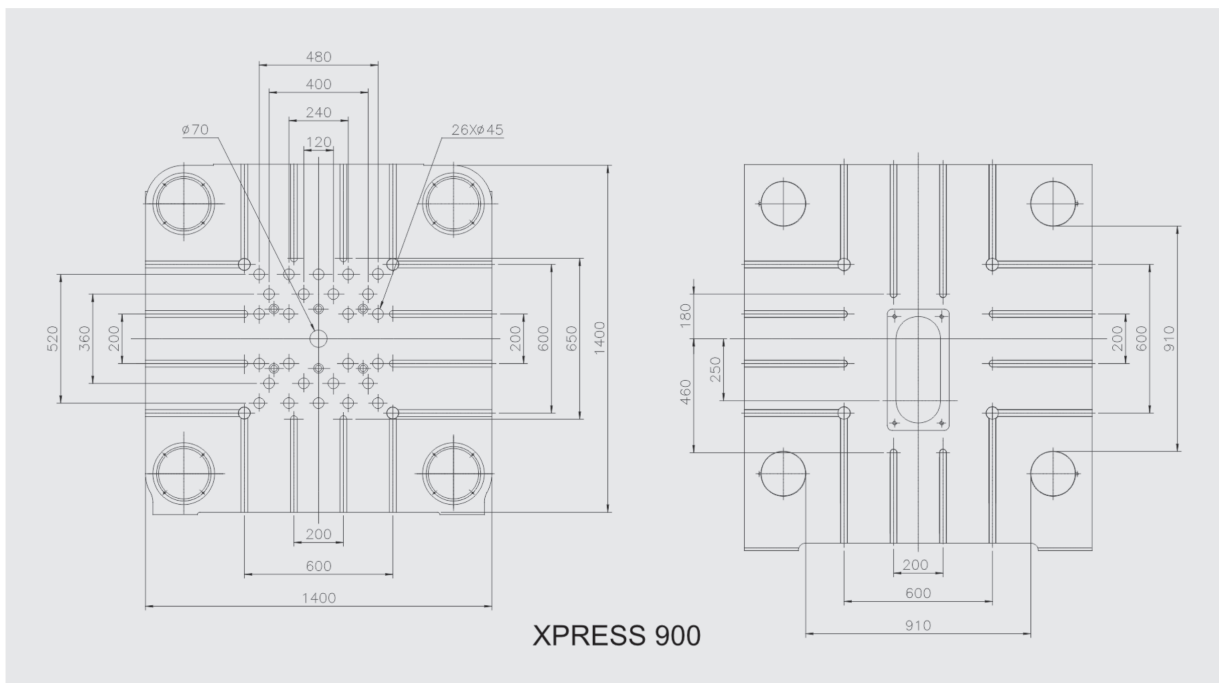
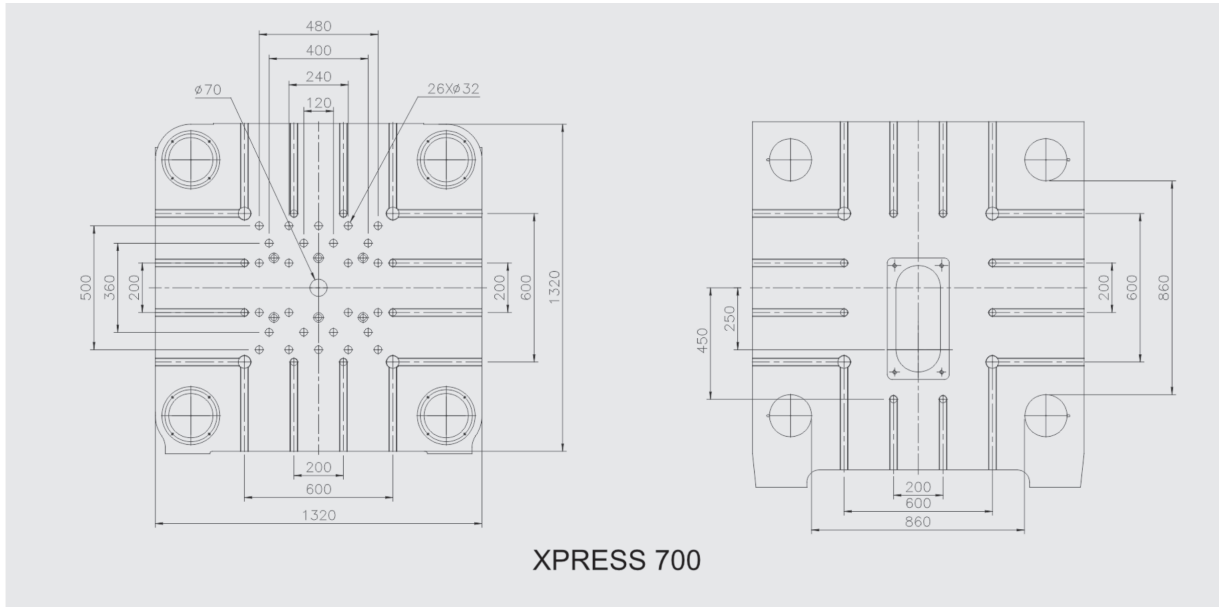

C1-001-08-2020



IDRA S.r.l.

Via dei Metalli, 2
25039 Travagliato (BS)
Italy
Tel: +39 030 2011 1
sales.italy@idragroup.com

IDRA NORTH AMERICA, INC.

1510 North Ann St.
Kokomo, Indiana 46901
USA
Tel: +1 765 459 0085
sales.usa@idragroup.com

IDRA CHINA LTD.

No. 42 MinYi Road,
SongJiang Area,
201612 Shanghai - P.R. China
Tel. +86 21 68751216
sales.china@idragroup.com

IDRA PRESSEN GmbH

Eisenbahnstrasse 6
73630 Remshalden Grunbach
Deutschland
Sales: +49 163 6364 802
Service: +49 163 6364 801
sales.germany@idragroup.com

IDRA MEXICO

Privada Micro #203
Parque Industrial Politek
66017 Garcia - NL Mexico
Tel: +52 813 581 4504
sales.mexico@idragroup.com



www.idragroup.com